



3.1.2 CH Dolby Atmos Soundbar and Subwoofer User Manual

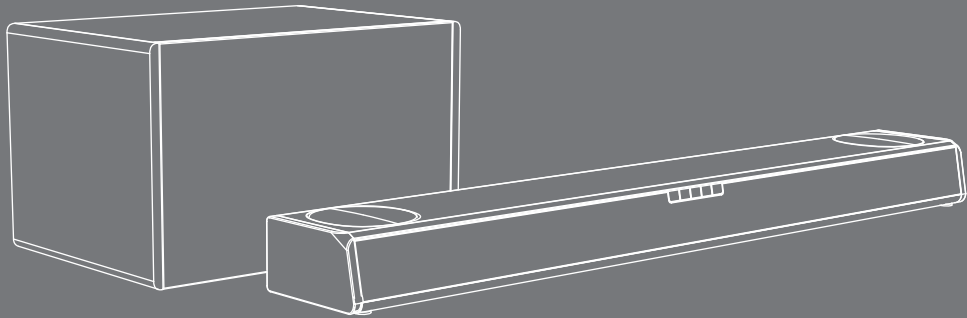

Table of contents

1.	Information about this user manual	01
1.1.	Explanation of symbols.....	01
2.	Proper use	03
3.	Safety information	04
3.1.	Ensure that the device is mounted securely	04
3.2.	Power supply	05
3.3.	Handling batteries	06
3.4.	Ambient temperature	07
3.5.	If there are defects	08
4.	Package contents.....	09
5.	Device overview.....	10
5.1.	Front.....	10
5.2.	Back.....	10
5.3.	Operating buttons and display (front)	10
5.4.	Connections (rear)	11
5.5.	Subwoofer (back)	12
5.6.	Remote control	13
6.	Preparing for first use	14
6.1.	Inserting batteries in the remote control	14
6.2.	Setting up the soundbar	14
6.3.	Wall mounting the soundbar.....	15
7.	Connecting audio devices.....	16
7.1.	Connecting audio devices via AUX IN	16
7.2.	Connecting audio devices via the optical connection	17
7.3.	Important information regarding HDMI CEC/HDMI ARC	17
7.4.	Connecting televisions via HDMI ARC.....	18
7.5.	Connecting other external devices via HDMI IN 1/HDMI IN 2	18
8.	Using the soundbar	18
8.1.	Connecting the soundbar and subwoofer to the power supply	18
8.2.	Switching the soundbar on/off.....	19
8.3.	Connecting the soundbar and subwoofer.....	19
9.	Connecting devices via Bluetooth®.....	20
10.	Operation	21
10.1.	Selecting the audio source	21
10.2.	Setting the display brightness.....	21
10.3.	Setting the volume	21
10.4.	Muting audio output	22
10.5.	Setting sound effects.....	22
10.6.	Setting the bass	22

10.7.	Setting the vertical surround sound effect.....	22
11.	Audio playback in Bluetooth® mode.....	22
12.	Maintenance	23
13.	Cleaning	23
14.	Storing the device when not in use.....	23
15.	Troubleshooting	24
16.	Trademark information.....	24
17.	Disposal	25
18.	Technical specifications	27
19.	Service information	28

1. Information about this user manual



Thank you for choosing our product. We hope you enjoy using this device.

Please read the safety instructions and the user manual carefully before using this product for the first time. Note the warnings on the device and in the user manual.

Always keep the user manual close to hand. If you sell the device or give it away, please ensure that you also pass on this user manual. It is an essential component of the product.

1.1. Explanation of symbols

If a block of text is marked with one of the warning symbols listed below, the hazard described in that text must be avoided to prevent the potential consequences described there from occurring.



DANGER!

Warning: risk of fatal injury!



WARNING!

Warning: risk of possible fatal injury and/or serious irreversible injuries!



CAUTION!

Warning: risk of minor and/or moderate injuries!



NOTICE!

Follow these instructions to prevent damage to the device!



More detailed information on using the device!



Follow the instructions in the user manual!



WARNING!

Warning: risk of electric shock!



WARNING!

Warning: danger due to loud volume!

Protection class II



Electrical devices in protection class II are devices that have double and/or reinforced insulation throughout, and do not have the option of connecting a protective earth. The housing of an electrical device in protection class II, with surrounding insulating material, might either form all of the additional or reinforced insulation, or part of it.



Indoor use

Devices with this symbol are intended solely for indoor use.



Symbol for direct current (DC)



Symbol for alternating current (AC)



FCC labelling

Products that feature this symbol meet the requirements of the FCC directives (see section entitled "Declaration of Conformity").

Manufactured under licence of Dolby Laboratories.



Dolby, Dolby Vision, Dolby Atmos and the double D symbol are registered trademarks of Dolby Laboratories.



The HDMI logo and High Definition Multimedia Interface are registered trademarks of HDMI Licensing LLC.

- Bullet point/information on steps during operation
- ▶ Instruction to be followed
- Safety instructions to be followed



2. Proper use

This device is designed to output audio signals. The soundbar is designed to be connected to televisions. It can also be connected to other devices, such as portable CD or MP3 players, computers/notebooks, smartphones and stereo systems.

The device is only intended for private use and not for industrial/commercial use.

Note that no liability will be accepted if this product is not used for its intended purpose:

- Do not modify the device without our express agreement and do not use any accessories that have not been supplied or approved by us.
- Only use replacement parts or accessories that we have supplied or approved.
- Comply with all the information in this user manual, especially the safety information. Any other use is considered improper and can cause personal injury or property damage.



3. Safety information



WARNING!

Risk of injury due to improper use!

- This device is not suitable for use by people (including children) with reduced physical, sensory or mental capabilities or with insufficient experience or knowledge unless properly supervised by a person responsible for their safety or these people have been instructed in how to use the device safely and have fully understood the possible dangers.
- Never leave children unattended near electrical equipment. Children are not always able to recognise and avoid possible dangers.

3.1. Ensure that the device is mounted securely



WARNING!

Risk of injury due to electric shock!

There is a risk of electric shock due to live cables and wiring.

- Install the device in a suitable location, and take care not to hit any hidden electrical cables or pipework when drilling.
- Do not place containers that are filled with liquid, e.g. vases, on or near the device and its mains cable. Such containers may tip over and the liquid may impair the electrical safety of the device.
- Protect the device and all other devices connected to it from dampness, water drops or water spray. To prevent malfunctions, keep the device dust-free, away from sources of heat, and out of direct sunlight.
- Do not place naked flames such as lit candles on or near the device.



- Do not use the device in potentially explosive atmospheres. This includes petrol stations, fuel storage areas and areas where solvents are processed, for example. This device must also not be used in areas with particle-laden air (for example flour or wood dust).
- Do not expose the device to extreme conditions. It is designed exclusively for use indoors.
Avoid:
 - high humidity or wet conditions
 - extremely high or low temperatures
 - direct sunlight
 - naked flames.
- Do not cover the device (with newspapers, covers etc.) to prevent overheating.
- Do not place any objects on the cables as they may be damaged.
- To prevent the device from falling, only install and operate it and its components on a sturdy, level, vibration-free surface.
- All multimedia devices that are connected to the device must comply with the requirements of the Low Voltage Directive.

3.2. Power supply



WARNING!

Risk of injury due to electric shock!

There is a risk of electric shock due to live cables and wiring.

- Install the device close to power sockets, which must always be easily accessible. Position the cables so that no one can tread on them or trip over them.
- To disconnect the device from the power supply, remove the device's plug from the power socket. Always hold the plug firmly when unplugging it. To prevent damage, never pull on the cable.



-
- Only operate the device from an earthed 100-240V ~ 50/60 Hz socket. Contact the local energy supplier if you have any questions about the power supply at the installation location.
 - Stop using the device's plug if the housing or the cable connecting it to the device are damaged.
 - Never open the device housing. Touching live parts or attempting to modify the device's electrical or mechanical functionality puts you at risk, and may also damage the device.
 - Disconnect the device from the power supply if it is not going to be used for a longer period of time or during a thunderstorm.

3.3. Handling batteries

The remote control is battery-operated. Please note the following:

- Keep new and used batteries out of the reach of children.
- Do not swallow batteries as they can cause chemical burns!



WARNING!

Risk of chemical burns!

The remote control contains two batteries. If these batteries are swallowed, they can cause serious internal chemical burns within two hours which may prove fatal.

- Seek medical help immediately if you think that batteries may have been swallowed or secreted in any part of the body.
- Remove leaking batteries from the device immediately. Clean the contacts before inserting new batteries. Avoid contact with the skin, eyes and mucous membranes. In the event of contact with battery acid, rinse the affected areas immediately with plenty of clean water and consult a doctor as soon as possible. Risk of chemical burns from battery acid!
- Stop using the remote control if you cannot close the battery compartment securely, and keep it well away from children.



WARNING!

Risk of explosion!

Risk of explosion if batteries are replaced incorrectly.

- There is a risk of explosion if batteries are replaced incorrectly! Always use new batteries of the same type. Never use old and new batteries together.
- Never try to recharge non-rechargeable batteries. Risk of explosion!
- Never expose the batteries to excessive heat (such as direct sunlight, fire or similar).
- Store batteries in a cool, dry place. Strong direct heat can damage batteries. Do not expose the device to sources of intense heat.
- Never short-circuit batteries.
- Never throw batteries into a fire.
- Pay attention to the polarity (+/-) when inserting the batteries.
- Remove flat batteries from the device.
- If the device is not going to be used for a longer period of time, remove the batteries.

3.4. Ambient temperature

- The device can be operated at an ambient temperature of 0 °C to +35 °C.
- When switched off, the device can be stored at temperatures of between -20 °C and +60 °C.
- Only use the device indoors in dry rooms.



DANGER!

Risk of electric shock!

Major changes in temperature or fluctuations in humidity can cause moisture to build up within the device due to condensation – this can cause an electrical short circuit.

- After transporting the device, wait until it has reached ambient temperature before switching it on.

3.5. If there are defects

- If the device or mains cable is damaged, unplug the mains cable from the power socket immediately.
- Do not use the device or its accessories if they are damaged, generate smoke or emit unusual operating noises. In this case, disconnect the power supply immediately.
- Never, under any circumstances, attempt to open and/or repair the device yourself.
- Contact our support email if you experience technical problems.

4. Package contents



DANGER!

Risk of choking and suffocation!

There is a risk of choking and suffocation if plastic film or small parts are breathed in or swallowed.

- Keep packaging away from children.
 - Do not allow children to play with the packaging material.
 - The packaging material is not a toy!
- ▶ Remove the product from the packaging and remove all packaging material.
 - ▶ Check your purchase to ensure that all items are included. If anything is missing, please contact our support email within 14 days of purchase.
 - ▶ Before each use, check the device for any damage.
 - ▶ Contact our support email if you find any damage.

The following items are supplied with your product:

- Soundbar
- Subwoofer
- Mains adapters for soundbar and subwoofer
- Remote control
- Wall mounts materials
- User manual include wall mounting template
- HDMI(ARC) cable(1x4.92ft)
- Optical cable(1x4.92ft)
- AUX cable(1x4.92ft)

5. Device overview

5.1. Front

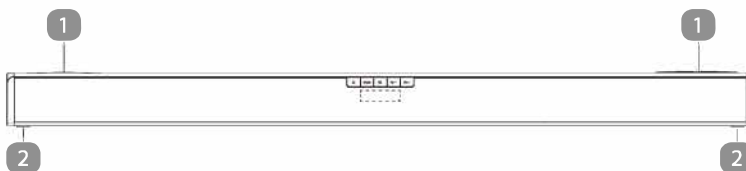

- 1) Speaker for vertical surround sound effect
- 2) Feet

5.2. Back

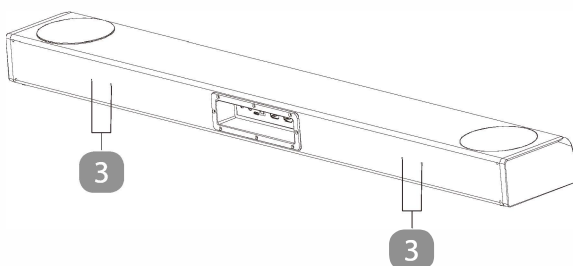

- 3) Pre-drilled holes for wall mounting

5.3. Operating buttons and display (front)

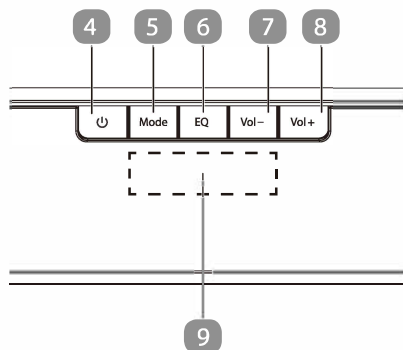

- 4)  Short press when not in use: set the display brightness
Press and hold when not in use: switch on the soundbar
Short press when in use: set the display brightness
Press and hold when in use: switch soundbar to standby mode

- 5) **Mode** Short press: select audio source
Press and hold: terminate/re-establish Bluetooth® connection
- 6) **EQ** Select equaliser settings
- 7) **Vol -** Short press: decrease the volume
Press and hold: continually decrease the volume
- 8) **Vol +** Short press: increase the volume
Press and hold: continually increase the volume
- 9) **Display**

5.4. Connections (rear)

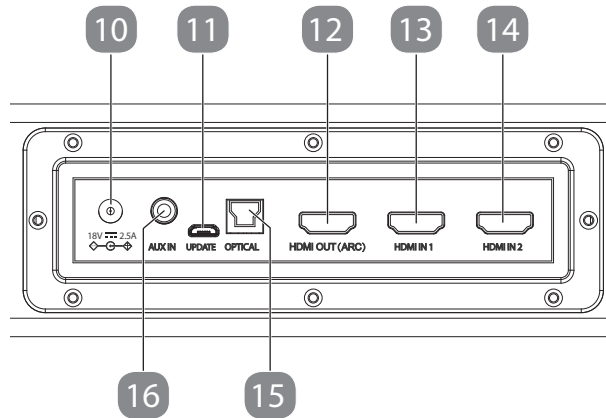

- 10) **18.0 V $\overline{\text{---}}$ 2.5A** Connection socket for mains adapter
- 11) **UPDATE** Software update port (**Only for authorised service personnel!**)
- 12) **HDMI OUT (ARC)** Output port for ARC-enabled TVs, computers and other audio output devices
- 13) **HDMI IN 1** Input port for DVD player and other audio output devices
- 14) **HDMI IN 2** Input port for DVD player and other audio output devices
- 15) **OPTICAL** Optical input for TV and other audio output devices
- 16) **AUX IN** Connection socket for TV and other audio output devices (3.5 mm jack)

5.5. Subwoofer (back)

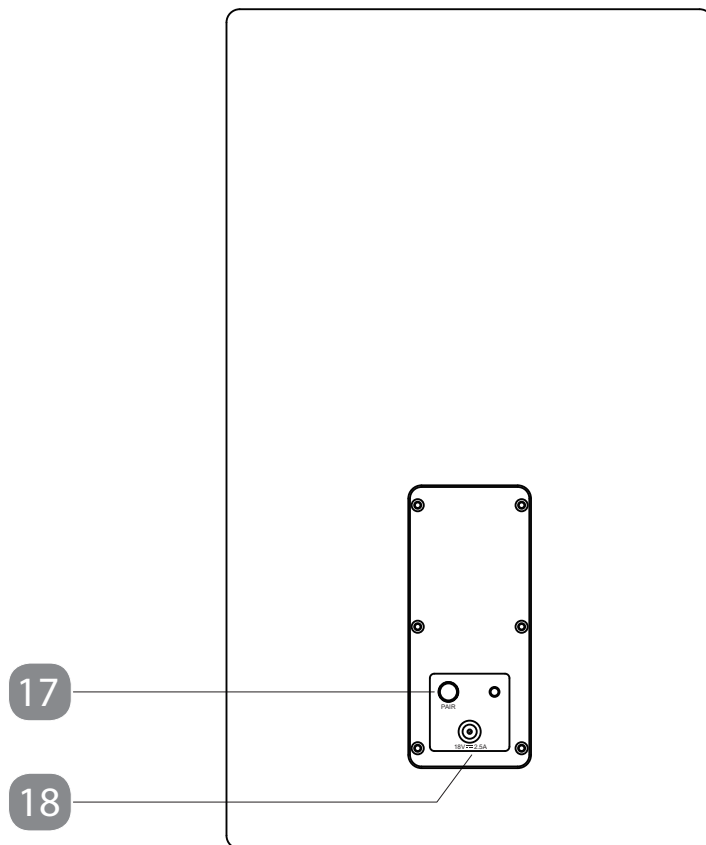

- 17) **PAIR** Press and hold: enable connection mode to manually connect the subwoofer to the soundbar
- 18) **AC** Connection socket for mains cable (100–240 V~, 50/60 Hz)

5.6. Remote control

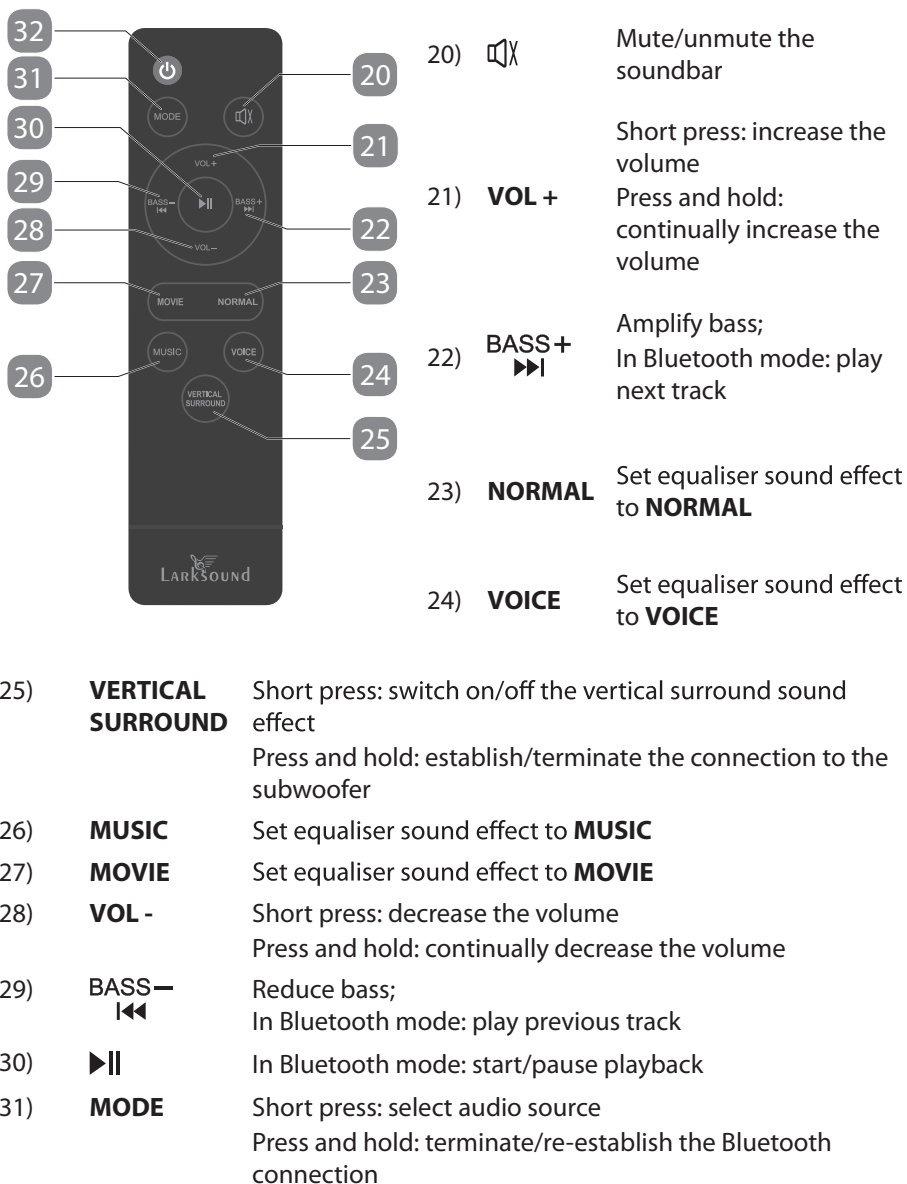



32) 

Short press when not in use: set the display brightness
Press and hold when not in use: switch on the soundbar
Short press when in use: set the display brightness
Press and hold when in use: switch soundbar to standby mode

6. Preparing for first use

6.1. Inserting batteries in the remote control

Replace the batteries before using the device for the first time or if the device fails to react to commands from the remote control properly.

To do so, proceed as follows:

- ▶ Gently press the battery compartment locking tab towards the bottom of the remote control and pull the battery compartment cover upwards to remove it.
- ▶ Remove the old batteries and dispose of them in accordance with legal regulations.
- ▶ Insert two new AAA (LR03) batteries. Check the battery polarity is correct.
- ▶ Place the battery compartment cover with the locking tab pointing upwards back onto the battery compartment and press it downwards until it audibly clicks into place.

6.2. Setting up the soundbar

- ▶ Position the soundbar and subwoofer on a stable, level surface close to an easily accessible power socket.
- ▶ Position the subwoofer close to the soundbar.

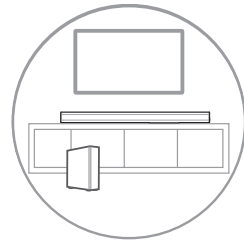

NOTICE! **Risk of damage!**

Risk of damage to the device due to improper use of the devices.

- To prevent the device from falling, only install and operate it and its components on a sturdy, level and vibration-free surface.
- Some aggressive varnishes can corrode the rubber feet on the device. If necessary, place the device on a non-slip underlay.



6.3. Wall mounting the soundbar

As an alternative to placing the device on a flat surface, you can mount the soundbar on a wall.



Before mounting on a wall, check that the wall has the required load bearing capacity. MEDION AG shall not be liable for damage resulting from incorrect or non-professional mounting.



WARNING!

Risk of injury due to electric shock!

There is a risk of electric shock due to live cables and wiring.

- Install the device in a suitable location, and take care not to hit any hidden electrical cables or pipework when drilling.

There are four pre-drilled holes on the back of the soundbar for fitting the supplied wall mounts.

- ▶ Attach the two wall mounts to the back of the device (one on the left and one on the right) using 2 of the supplied screws for each wall mount (**see illustration, step 1**).
Make sure that the narrower part of the screw openings points upwards (**see illustration, item A**).

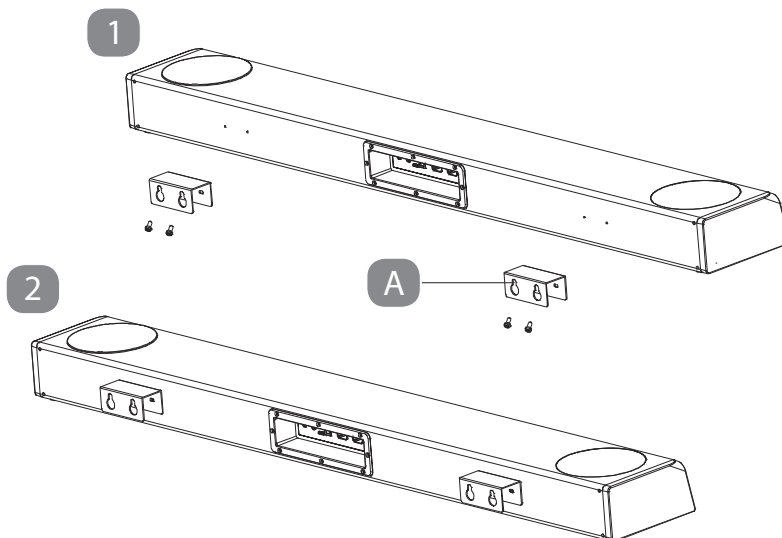

-
- ▶ Hold the wall mounts in place at the desired mounting point and mark the four drill holes required.
 - ▶ Please use wall mounting template for the distance between the two wall mounts.
 - ▶ Drill the holes. To do so, use an appropriate drill bit for the respective surface (dia. 6 mm, depending on the wall type).
 - ▶ Push the wall plugs (M6 x 26) into the drill holes.
 - ▶ Screw four screws into the drill holes. Leave the screw heads protruding from the wall by approx. 2mm.
 - ▶ Place the wider part of the wall mounts on the screw heads, then gently press the soundbar downwards until the screws lock into place on the wall mounts.

7. Connecting audio devices

You can connect a wide range of different audio output devices to the soundbar, such as a television, MP3 or CD player, receiver, computer etc.

- ▶ Switch off all the devices before connecting them to each other.



Also comply with the information in the user manual for the device you want to connect to the soundbar.

7.1. Connecting audio devices via AUX IN

7.1.1. Audio cable with 2 x 3.5 mm diameter jacks

You will need an audio cable with 2 x 3.5 mm diameter jacks (supplied) to connect an output device to the soundbar using the headphone output socket on the output device.

- ▶ Set the output device to a medium volume level and then switch it off.
- ▶ Insert the jack plug into the soundbar's **AUX IN** socket.
- ▶ Insert the other jack plug into the headphone output socket on the output device.

7.1.2. Audio cable with cinch plugs

You will need an audio cable with cinch plugs, 1 x 3.5 mm jack -> 2 x cinch (not supplied) to connect an audio device to the soundbar using the cinch outputs on the audio device.

- ▶ Set the output device to a medium volume level and then switch it off.
- ▶ Insert the jack plug into the soundbar's **AUX IN** socket.
- ▶ Insert the red and white cinch plugs at the other end of the cable into the corresponding colour-coded output sockets on the audio device.



Devices such as stereo receivers or televisions usually have one red and one white audio output socket. These are usually marked as OUT, AUDIO OUT, LINE OUT or similar.

7.2. Connecting audio devices via the optical connection

You can connect digital amplifiers or televisions with an optical digital output to the soundbar via the **OPTICAL** connection. To do this, you will need an optical digital cable (supplied)

- ▶ Set the output device to a medium volume level and then switch it off.
- ▶ Plug the optical digital cable connector into the **OPTICAL** connection socket on the soundbar.
- ▶ Plug the other optical digital cable connector into the corresponding digital output socket on your output device.



If no sound is output, switch the audio output format on your output device to PCM (Pulse Code Modulation) mode.

7.3. Important information regarding HDMI CEC/ HDMI ARC

7.3.1. HDMI CEC (Consumer Electronics Control)

CEC enables all devices connected via HDMI to communicate with each other. This connection then means that you can use the remote control for your television, for example, to adjust the volume on your device or mute it.

In order to use HDMI CEC functions, all components connected must support HDMI CEC. The name and range of functions may vary depending on the manufacturer. To this end, please note the information in the user manual for the device in question. All HDMI cables that support HDMI 1.3 standard or later also support HDMI CEC.

7.3.2. HDMI ARC (Audio Return Channel)

Using ARC means not only that audio signals are received via HDMI, but that these signals can also be sent back along the same cable.

In order to use HDMI ARC functions, all components connected must support HDMI ARC. In addition, you will need at least one "High Speed" HDMI cable (version 1.4 or later, supplied).

7.4. Connecting televisions via HDMI ARC

Proceed as follows to connect your television to the soundbar via HDMI ARC:

- ▶ Set the volume on your television to a medium level.
- ▶ Switch off the television and the soundbar.
- ▶ Connect the **HDMI OUT (ARC)** port on the soundbar to the HDMI IN (ARC) port on your television.
- ▶ Enable the ARC and CEC functions on your television and set the sound output to PCM (Pulse Code Modulation), if necessary.



Please note that the name of the HDMI IN ARC port and the CEC function may vary depending on the manufacturer of your television. For more detailed information, refer to the corresponding user manual.

7.5. Connecting other external devices via HDMI IN 1/ HDMI IN 2

You can connect other audio output devices with HDMI ports (e.g. game consoles, receivers etc.) to the soundbar using the **HDMI IN 1** or **HDMI IN 2** port.

To do so, proceed as follows:

- ▶ Set the volume on your audio output device to a medium level.
- ▶ Switch off the audio output device and the soundbar.
- ▶ Connect a suitable HDMI cable (not supplied) to the HDMI OUT port on your audio output device.
- ▶ Connect the other end of the HDMI cable to the **HDMI IN 1** or **HDMI IN 2** port on the soundbar.



Also comply with the user manuals for the external devices.

8. Using the soundbar

8.1. Connecting the soundbar and subwoofer to the power supply

- ▶ Check that all the devices you want to connect are connected to the soundbar.
- ▶ Connect the supplied mains adapter to the connection socket (**18.0V**  **2.5 A**) on the soundbar and plug the other end into an easily accessible power socket.

STDBY appears on the display.

- ▶ Plug the permanently installed mains cable **AC** on the subwoofer into an easily accessible power socket.

8.2. Switching the soundbar on/off

- ▶ Switch on the soundbar by pressing and holding the  button on the remote control or the soundbar.



The soundbar switches on and starts. This process takes several seconds, during which time **ON** flashes on the display. As soon as the soundbar has started fully, the last selected source is shown on the display.



If a TV or an external device is connected via the **AUX** socket or **HDMI** ports, the soundbar will switch on automatically a few seconds after the television or the external device is switched on.

If the TV or the external device is disconnected or switched off, the soundbar will switch off automatically after approximately 15 minutes. If the volume of the television or external device is set too low, the soundbar will also switch off after approximately 15 minutes (but only if the devices are connected via AUX).

- ▶ When the device is in use, press and hold the  button on the soundbar or on the remote control to switch the soundbar into standby mode.

8.3. Connecting the soundbar and subwoofer



The soundbar and subwoofer connect automatically the first time they are used. Once the connection is successful, the **Pairing LED** on the back of the subwoofer lights up blue continuously.

If the **Pairing LED** is flashing, the automatic connection has failed. To connect the devices manually, proceed as follows:

- ▶ Switch on the soundbar, and power up the subwoofer.
- ▶ Press and hold the **PAIR** button on the back of the subwoofer until the **Pairing LED** flashes quickly.
- ▶ Next, press and hold the **VERTICAL SOUND** button on the remote control until the connection process starts and **SW P** is shown on the soundbar display.

The **Pairing LED** lights up blue continuously as soon as the connection between the soundbar and subwoofer has been established successfully.



If the subwoofer is switched on after the soundbar, it always starts with the bass level set to 30% by default. Use the  and  buttons to set the desired bass level.

9. Connecting devices via Bluetooth®

In Bluetooth mode, you can receive audio signals wirelessly from an external Bluetooth-enabled audio output device. Make sure the two devices are not more than 10 metres apart.



Only one Bluetooth device can be paired with the soundbar at a time.

To connect a Bluetooth-enabled audio output device, proceed as follows:

- ▶ Switch on the soundbar.
- ▶ Then press the **MODE** button on the soundbar or remote control until **BLUE** is shown on the display.

The device is now in connection (pairing) mode.



The soundbar attempts to automatically connect itself to the last audio output device connected via Bluetooth. If this is not possible, the device remains in search mode and **BLUE** flashes on the display.

- ▶ Switch on the Bluetooth function on your audio output device and activate search mode on it to pair the two devices.



For more information about the Bluetooth function of your audio output device, please refer to its user manual.

The device name of the soundbar "**LARK S312**" will be displayed in the device list on your audio output device as soon as the signal is found.

- ▶ Select the soundbar and pair the two devices. If you are prompted to enter a password, enter "**0000**".

Device pairing is complete when **BLUE** lights up continuously on the display and the soundbar emits an acoustic signal.

- ▶ To disconnect an active Bluetooth connection, press and hold the **MODE** button on the remote control or the soundbar until **BLUE** flashes on the display and an acoustic signal is emitted from the soundbar.
- ▶ To re-establish the Bluetooth connection with the last connected device, press and hold the **MODE** button on the remote control or soundbar until **BLUE** lights up on the display continuously and an acoustic signal is emitted from the soundbar.



If you have connected the soundbar to a Bluetooth device that supports the A2DP and AVRCP profiles (Audio Video Remote Control), the soundbar is used as an output medium and the audio signals are only output through the soundbar.

In case of an incoming call, music playback is interrupted and only continues when the call has ended.



For additional operating controls, use the controls on your audio output device.

10. Operation

10.1. Selecting the audio source

- ▶ Press the **MODE** button on the remote control or the soundbar once or several times to select the desired audio source.

The selected audio source is shown on the display:

Display	Operating mode
"STDBY"	Standby mode
"AUX"	AUX IN operating mode
"BLUE"	Bluetooth mode
"HDMI1/HDMI2"	HDMI IN 1 or HDMI IN 2 operating mode
"ARC"	HDMI OUT (ARC) operating mode
"OPT"	OPTICAL operating mode

10.2. Setting the display brightness

- ▶ In standby mode or when the device is in use, press the  button on the soundbar or the remote control to set one of three display brightness levels.

10.3. Setting the volume

- ▶ Press the **Vol +** button on the soundbar or on the remote control to increase the volume.
- ▶ Press the **Vol -** button on the soundbar or on the remote control to decrease the volume.

The current volume setting is shown on the display.

- ▶ Press and hold **Vol + / Vol -** to continuously increase/decrease the volume. Release the button when the desired volume setting is displayed.

10.4. Muting audio output



- ▶ Press the  button on the remote control to mute audio playback on the soundbar.

When the mute function is active, **MUTE** flashes on the display.

10.5. Setting sound effects

- ▶ Press the **EQ** button on the soundbar or one of the **NORMAL**, **VOICE**, **MOVIE**, **MUSIC** buttons on the remote control to set the corresponding sound effect.

10.6. Setting the bass

- ▶ Press the  button on the remote control to amplify the subwoofer base effect.
- ▶ Press the  button on the remote control to reduce the subwoofer base effect.

The corresponding bass setting in the control range -5 to +5 is shown on the display.

10.7. Setting the vertical surround sound effect

Use the **VERTICAL SURROUND** button on the remote control to set the vertical surround sound effect.

- ▶ Press the **VERTICAL SURROUND** button to switch on the sound effect. **SR ON** is shown on the display.
- ▶ Press the **VERTICAL SURROUND** button again to switch off the sound effect. **SR OFF** is shown on the display.





When playing back audio/video material with a Dolby Atmos™ soundtrack, **ATMOS** is shown on the soundbar display when playback starts. When playing back audio/video material without a Dolby Atmos™ soundtrack, **PCM** is shown on the soundbar display when playback starts.

11. Audio playback in Bluetooth® mode

If you have connected the soundbar to a device that supports the A2DP and AVRCP profiles (Audio Video Remote Control), the soundbar is used as an output medium and all audio signals are only output via the soundbar.



If you have connected the soundbar with your Bluetooth-enabled mobile phone, the music playing through the soundbar is interrupted when you receive a call, and only continues when you finish the call.

- ▶ Press the  button on the remote control to start playing tracks.
- ▶ To pause playback, press the  button again. Press this button again to resume playback.
- ▶ During playback, press the  button once to jump to the start of the track.

-
- ▶ Press the **BASS+** button to skip to the next track.

12. Maintenance



WARNING

Risk of injury due to electric shock!

- Never, under any circumstances, attempt to open or repair the device yourself. There is a risk of electric shock!

Please contact our Service Centre if you have technical problems with your device. Repairs must only be performed by our authorised service partners.

Contact our Service Centre if...

- the device is not working correctly
- liquid has got into the device
- the device has been dropped or its housing is damaged.

13. Cleaning

- Before cleaning the devices, always disconnect them from the power supply by unplugging the mains plug.
- Only use a dry, soft cloth to clean the device. Do not use chemical solutions or cleaning products because these may damage the device's surface and/or inscriptions.

Furniture is often coated with varnishes or plastics which are cleaned with a wide range of cleaning agents. Some of these cleaning agents contain ingredients which might damage the soundbar's base material, and cause it to become soft.

- If necessary, place a non-slip mat underneath.

14. Storing the device when not in use

- ▶ If you do not intend to use the devices over a longer period of time, unplug them from the power supply and store in a cool, dry place.
- ▶ Ensure that the devices are protected from dust, dirt and extreme temperature variations.

15. Troubleshooting

- ▶ If the device stops working properly, please refer to the troubleshooting table shown below to see if you can resolve the problem yourself.
- ▶ Never attempt to repair the device yourself. If a repair is necessary, please contact our Service Centre or a suitable authorised repair workshop.

Cause	Troubleshooting
Faulty connections and cables	<ul style="list-style-type: none">▶ Check all the cable connections for damage, ensure the correct cables have been used and check that the Bluetooth® connection is active.▶ Check that all the connected devices have an adequate electricity supply.
No sound can be heard	<ul style="list-style-type: none">▶ Check the volume setting on the output device. If necessary, increase the volume.
Distorted sound	<ul style="list-style-type: none">▶ Change the position of the soundbar to avoid disruptive external influences.▶ Move the objects responsible for the distortion (mobile phone or similar) away from the device.
No bass from the subwoofer	<ul style="list-style-type: none">▶ Check if the subwoofer is connected to the soundbar and, if necessary, connect the devices manually.

16. Trademark information

The HDMI logo and High Definition Multimedia Interface are registered trademarks of HDMI Licensing LLC.

The Bluetooth® word mark and logos are registered trademarks of Bluetooth SIG, Inc. and are used by the manufacturer under licence.

The USB™ word mark and logos are registered trademarks of the USB Implementers Forum, Inc. and are used by the manufacturer under licence.

Dolby, Dolby Audio, Dolby Atmos and the double D symbol are registered trademarks of Dolby Laboratories and are used by the manufacturer under licence.

Other trademarks are the property of their respective owners.

17. Disposal



PACKAGING

Your device has been packaged to protect it from damage in transit. The packaging is made of materials that can be recycled in an environmentally friendly manner.



DEVICE

All old devices marked with the symbol shown must not be disposed of in normal household waste.

In accordance with Directive 2012/19/EU, the device must be properly disposed of at the end of its service life.

This involves separating the materials in the device for the purpose of recycling and minimising the environmental impact.

Take old devices to an electrical scrap collection point or a recycling centre. Before doing so, remove the batteries from the remote control and take them to a separate collection point for used batteries.

Contact your local waste disposal company or your local authority for more information on this subject.



BATTERIES

Do not dispose of used batteries with normal household rubbish.

Batteries must be disposed of correctly. For this purpose, retailers that sell batteries and local collection points provide containers in which you can dispose of them. Contact your local waste disposal company or your local authority for more information.

In connection with the sale of batteries or the supply of devices containing batteries, we are obliged to draw your attention to the following:

As the end user, you are legally required to return used batteries.

The crossed-out wheeled bin symbol means that the battery must not be disposed of with household rubbish.

FCC Compliance

NOTE: This equipment has been tested and found to comply with the limits for a Class B digital device, pursuant to part 15 of the FCC Rules. These limits are designed to provide reasonable protection against harmful interference in a residential installation. This equipment generates uses and can radiate radio frequency energy and, if not installed and used in accordance with the instructions, may cause harmful interference to radio communications. However, there is no guarantee that interference will not occur in a particular installation. If this equipment does cause harmful interference to radio or television reception, which can be determined by turning the equipment off and on, the user is encouraged to try to correct the interference by one or more of the following measures:

- Reorient or relocate the receiving antenna.
- Increase the separation between the equipment and receiver.
- Connect the equipment into an outlet on a circuit different from that to which the receiver is connected.
- Consult the dealer or an experienced radio/TV technician for help

Changes or modifications not expressly approved by the party responsible for compliance could void the user's authority to operate the equipment.

This device complies with Part 15 of the FCC Rules. Operation is subject to the following two conditions:

- (1) this device may not cause harmful interference, and
- (2) this device must accept any interference received, including interference that may cause undesired operation.

18. Technical specifications

Soundbar

Dimensions (WxHxD):	90 x 7.0 x 12.8 cm
Weight:	3.9 kg
Input voltage:	18.0V \approx 2.5A
Maximum transmission power:	<-10 dBm
Subwoofer transmission frequency:	5732 MHz ~ 5848 MHz
Power output:	Front speaker: 2 x 8.0 W RMS Top speaker: 2 x 18 W RMS Center speaker: 1 x 18 W RMS
Connections:	1 x 3.5 mm jack audio input 1 x digital audio input (optical) 2 x HDMI inputs 1 x HDMI (ARC) output with CEC Mains cable connection 1 x micro USB port (only for service updates)
Supported formats:	Dolby® Digital, Dolby Digital Plus™, Dolby® TrueHD, Dolby Atmos®, Dolby® Vision
Bluetooth specification:	V5.0, Class II
Bluetooth profile:	A2DP, AVRCP
Max. Bluetooth transmission power:	3.9 dBm
Bluetooth frequency:	2402 MHz ~ 2480 MHz
Bluetooth range:	Max. 10 m (depending on environmental conditions)

Subwoofer

Dimensions (WxHxD):	26 x 38 x 22 cm
Weight:	4.1 kg
Input voltage:	18.0 V  2.5A
Power consumption:	45 W
Power output:	1 x 40 W RMS

General data

Ambient temperature (during operation):	0 °C to +35 °C at a relative air humidity of max. 80% (non-condensing)
Ambient temperature (storage):	-20 °C to +60 °C at a relative air humidity of max. 80% (non-condensing)
Remote control:	2 x 1.5 V  batteries, AAA LR03 (supplied) Range: approximately 6 m

19. Service information

Please contact for support via support@larksound.com if your device ever stops working the way you want or expect it to.



Made in China

